

KLT-ENT-IMX214 V2.2

13MP Sony IMX214 MIPI Interface Auto Focus Camera Module

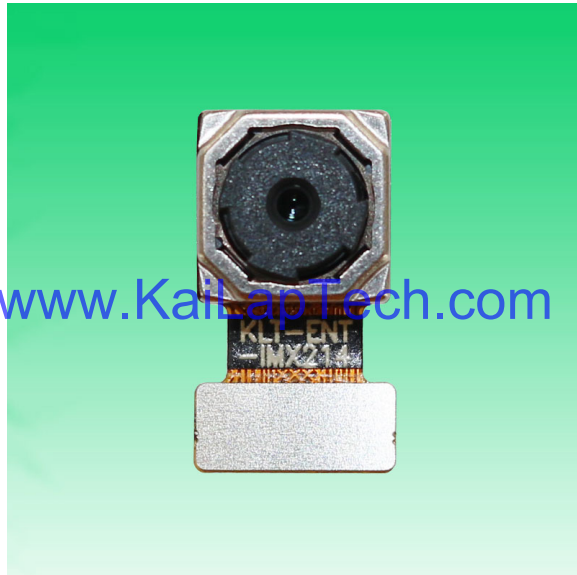

Front View

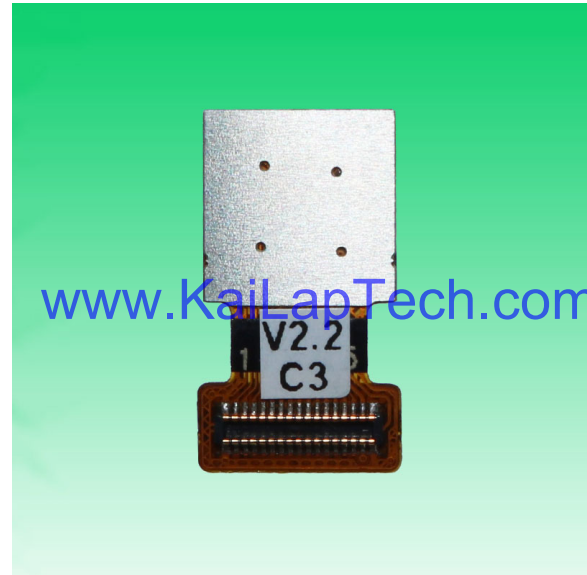

Back View

Specifications

| | |
|--------------------------|-------------------------------------|
| Camera Module No. | KLT-ENT-IMX214 V2.2 |
| Resolution | 13MP |
| Image Sensor | IMX214 w/ Blue Film |
| Sensor Type | 1/3.06" |
| Pixel Size | 1.12 um x 1.12 um |
| EFL | 2.80 mm |
| F.NO | 1.90 |
| Pixel | 4224 x 3136 |
| View Angle | 90.3°(DFOV) 77.4°(HFOV) 62.0°(VFOV) |
| Lens Dimensions | 8.50 x 8.50 x 5.35 mm |
| Module Size | 16.07 x 9.00 mm |
| Module Type | Auto Focus |
| Interface | MIPI |
| Auto Focus VCM Driver IC | FP5510 |
| Lens Model | KLT-LENS-50156A1-00 |
| Lens Type | 650nm IR Cut |
| Operating Temperature | -20°C to +70°C |
| Mating Connector | BM20B(0.8)-30DS-0.4V(51) |



KLT-ENT-IMX214 V2.2

13MP Sony IMX214 MIPI Interface Auto Focus Camera Module



Top View



Side View

www.KaiLapTech.com

www.KaiLapTech.com

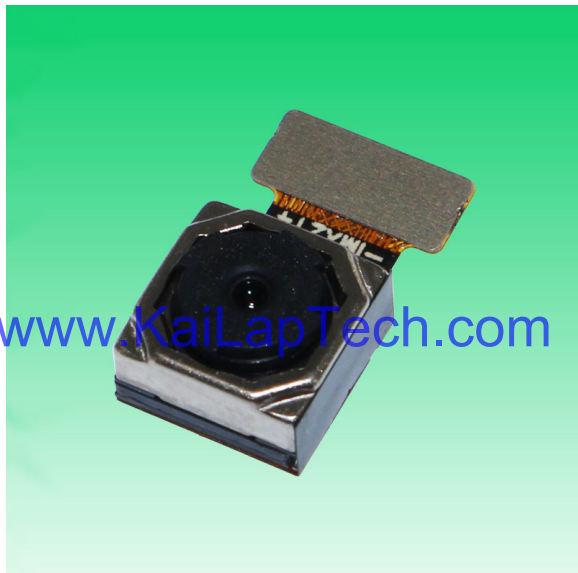

Bottom View



Mating Connector

RoHS

| | |
|----|-------------|
| 1 | MDN1 |
| 2 | MDP1 |
| 3 | DGND |
| 4 | MDN3 |
| 5 | MDP3 |
| 6 | DGND |
| 7 | MDN0 |
| 8 | MDP0 |
| 9 | DGND |
| 10 | MDN2 |
| 11 | MDP2 |
| 12 | DGND |
| 13 | MCN1 |
| 14 | MGP |
| 15 | AGND |
| 16 | AF_VDD 2.8V |
| 17 | AVDD 2.8V |
| 18 | DVDD 1.05V |
| 19 | D0VDD 1.8V |
| 20 | NC |
| 21 | XCLK |
| 22 | NC |
| 23 | NC |
| 24 | SCL |
| 25 | SDA |
| 26 | RESET |
| 27 | NC |
| 28 | NC |
| 29 | NC |
| 30 | NC |

NOTE:

1. The device slave address: 0x20(w); 0x24(r)

Parameters:

1. Sensor specification:

Image Sensor: IMX214
 Pixel: 1.12um×1.12um
 Lens Type: 1/3.06
 Important Voltage Description: DVDD1.05V
 (External power supply);

2. Lens specification:

FOV: 90.3°(D); 77.4°(H); 62°(V)
 F#NO.: 1.9
 TV distortion: <1.0%
 Focal length: 2.8mm
 Composition: 5P+IR FILTER
 IR Cut Coating: 650nm±10nm@50%

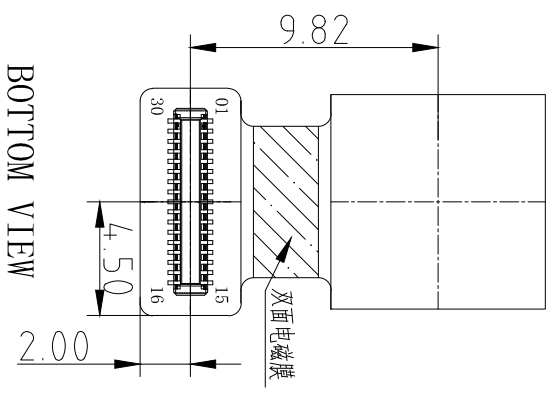
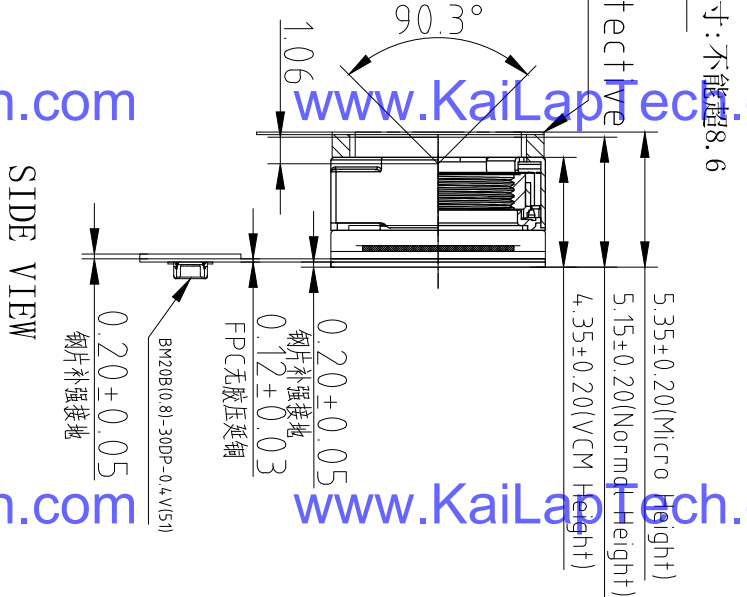
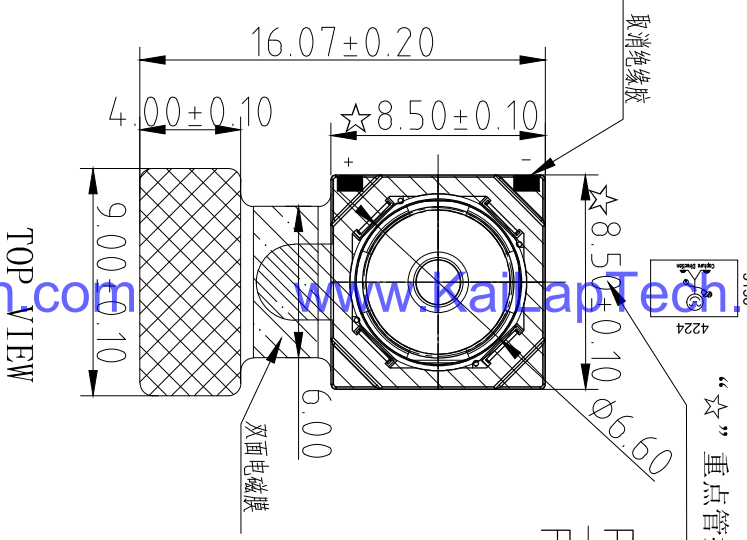

“☆”重点管控尺寸: 不能超过8.6

| Version | Information | Date |
|---------|---------------------|-----------|
| V2.0 | First Version | 12-5-2018 |
| V2.2 | Change lens and VCM | 2-14-2022 |

Kai Lap Technologies Group Ltd

| | | | | | |
|-------------|-----------|------------------|---------------------|-----------|--------|
| Designed By | Keys | Model Name: | KLT-ENT-IMX214 V2.2 | | |
| Checked By | Aouly_Yan | Projection Type: | Unit: | Material: | |
| | | Third Angle | mm | | |
| | | Scale: | 1:1 | Sheet: | 1 of 1 |
| | | | | Version: | 1/0 |



Lens Model: KLT-LENS-50156A1-00

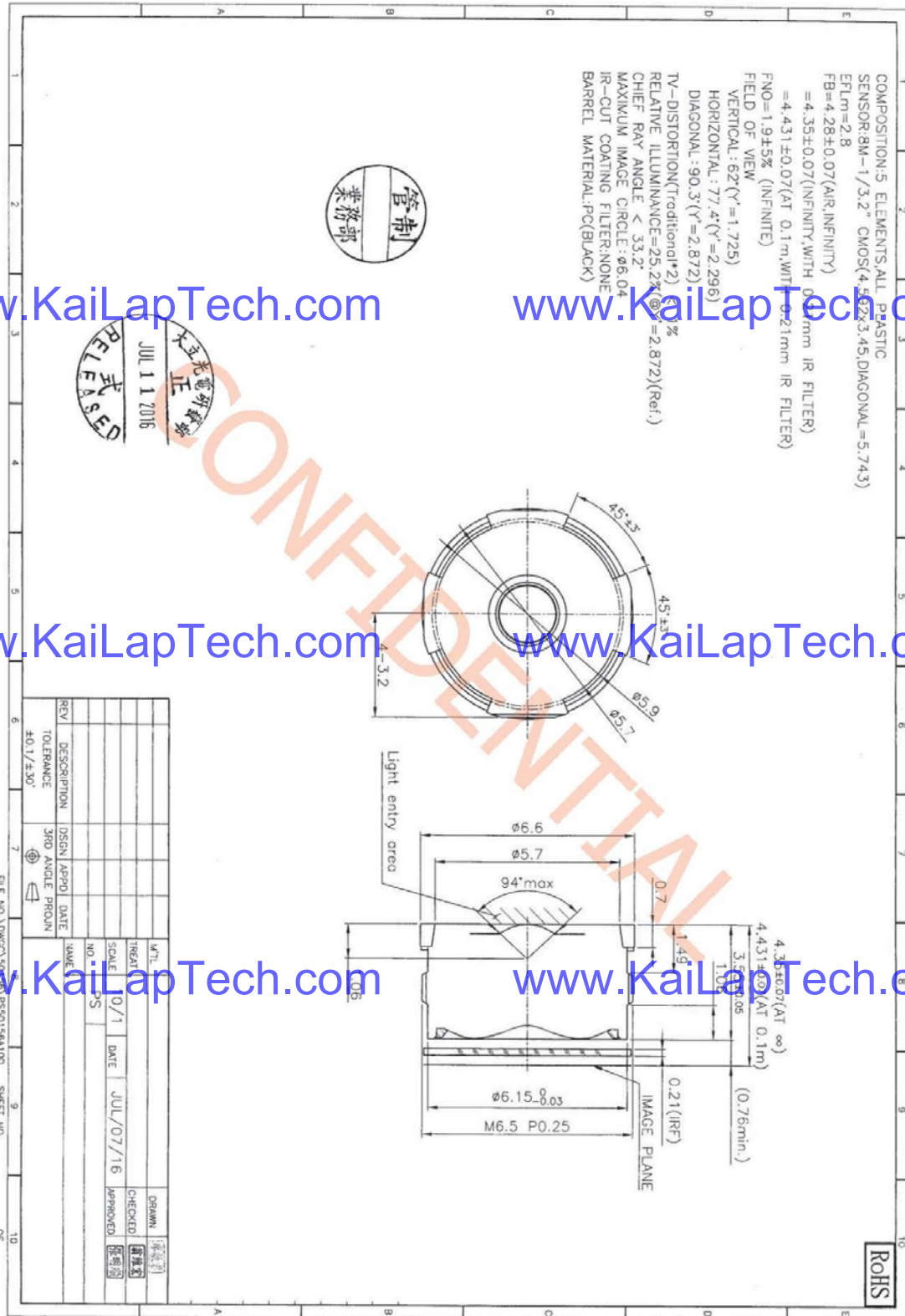

www.KaiLapTech.com

www.KaiLapTech.com

www.KaiLapTech.com

www.KaiLapTech.com

www.KaiLapTech.com

www.KaiLapTech.com

10-Bit DAC 120mA VCM Driver with I²C Interface

Description

The FP5510 is a single 10-bit DAC with 120mA output current voice coil motor (VCM) driver, with an I²C-compatible serial interface that operates at clock rates up to 400kHz. Its supply operates from 2.3V to 3.6V.

The FP5510 incorporates with a power-on reset circuit, power-down function. Power-on reset circuit ensure when supply power up, DAC output is to 0V until valid write bit value takes place. In power down mode, the supply current is about 1µA.

The FP5510 is designed for auto focus operation includes digital camera module, optical zoom camera phones and lens auto focus. The I²C address of FP5510 is 0x18h.

The FP5510 with WLCSP package which it is suitable for reduced-space mounting in mobile phone and other portable applications.

Pin Assignments

6-Ball WLCSP

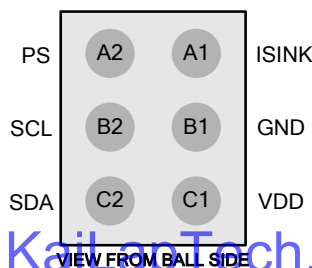

Figure 1. Pin Assignment of FP5510

Features

- Power Supply Voltage Rang: 2.3V to 3.6V
- VCM Driver for Auto-Focus
- 10-Bit Resolution Current Sinking of 120mA for VCM
- 2-Wire I²C Interface (1.8V Interface Compatible)
- Internal 4 Slope Control Mechanism
 1. Enhance Slope Control Mode
 2. One Step Mode
 3. Linear Slope Mode
 4. Two Step Slope Mode
- Power-Save Mode Current < 1µA
- Power On Reset (POR)
- Small Size: 0.7mm×1.1mm (6-Balls WLCSP)

Applications

- Digital Camera Module
- Cell Phone
- Lens Cover
- Web Camera

Ordering Information

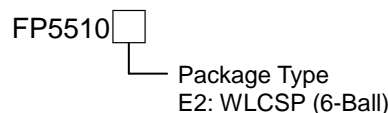

WLCSP-6 (0.7mm×1.1mm) Marking

| Part Number | Product Code |
|-------------|--------------|
| FP5510E2 | 2 |

0.4mm Pitch, 0.6 and 0.8mm Height, Board-to-Board and Board-to-FPC Connectors

BM20 Series

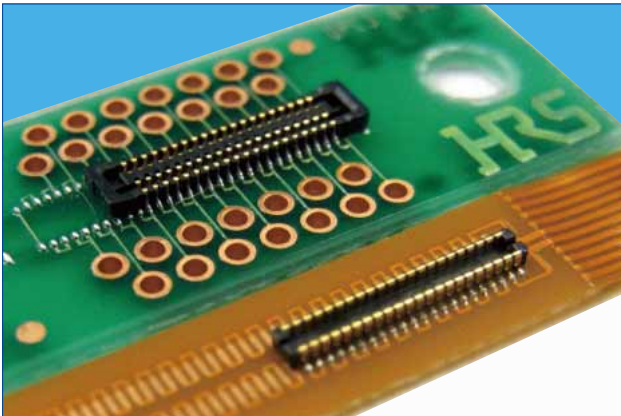

www.KaiLapTech.com

■ Features

1. High density mounting capability

A space saving design that keeps the connector compact, but still maintains an adequate vacuum area (no less than 0.7mm wide).
Depth DS : 2.3mm DP : 1.78mm

2. Reliable contact performance

Even though the mated height is low, the BM20 still leads it class in maximum effective mating lengths for each mating height.

<Effective Mating Length>

Height 0.8mm : 0.2mm

Height 0.6mm : 0.15mm

The addition of the two point contact system adds more reliability to the contacts.

3. No restrictions to PCB pattern design for the 0.8 mm height connector *1

This series utilizes a thin wall to insulate the bottom surface of the connector and maintains an effective mating length of 0.2mm. This removes any restriction for PCB pattern layout design under the connector.

Note *1: There are some restrictions for the 0.6 mm height style.

4. Enhanced mating operations

The structure uses guide ribs to ease the mating process and offers a self alignment range of up to 0.3mm. A clear tactile click is used as an indicator to the user that the mating process was completed.

5. Drop and shock resistant structure

Dimples were designed into the contacts to increase their retention force and to absorb the shock delivered from a drop or other impact.

6. Debris resisting design

When mated, the connector's design covers the contacts which help to keep dust and other debris away from the contacts. The SMT leads are kept very close to the connector housing which also helps to prevent shorts caused by debris on the exposed contacts

■ Receptacle

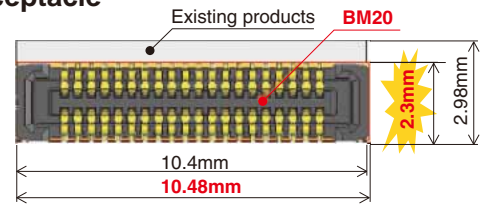

| Existing products | BM20 |
|---|---|
| 2.98×10.4 = About 31.0mm ² | 2.3×10.48 = About 24.1mm ² |

■ Header

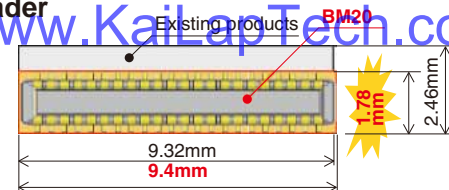

| Existing products | BM20 |
|---|--|
| 2.46×9.32 = About 22.9mm ² | 1.78×9.4 = About 16.7mm ² |

www.KaiLapTech.com

Vacuum pick-up

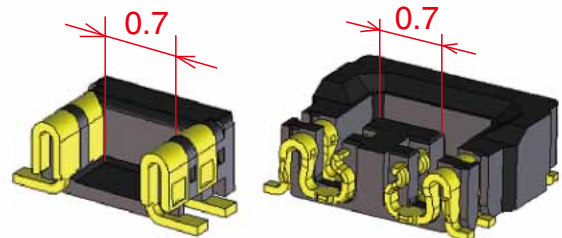

Mating diagram (cross section)

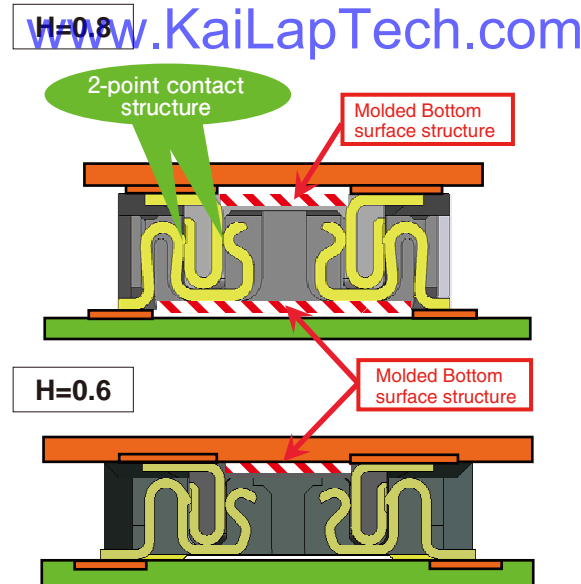

Product Specifications

| Ratings | Rated Current | 0.3A | Operating Temperature Range | - 35 ~ 85°C (Note 1) | Storage Temperature Range | - 10 ~ 60°C (Note 2) |
|------------------------------|--|------------|---|----------------------|---------------------------|----------------------|
| | Rated Voltage | AC, DC 30V | Operating Humidity Range | 20 ~ 80% | Storage Humidity Range | 40 ~ 70% (Note 2) |
| Items | Specifications | | Conditions | | | |
| 1. Insulation Resistance | Minimum of 50MΩ | | Measured with DC 100V | | | |
| 2. Withstanding Voltage | No flashover or breakdown | | Apply AC 100V for 1 minute | | | |
| 3. Contact Resistance | Maximum of 100mΩ | | Measured with AC 20 mV, 1 kHz and 1 mA | | | |
| 4. Vibration Resistance | No electrical discontinuity of 1μs or greater | | Frequency 10-55 Hz, half amplitude 0.75mm, 3 directions for 2 hours | | | |
| 5. Humidity Resistance | Contact resistance Maximum of 100mΩ Insulation resistance Minimum of 25mΩ | | Left at temperature 40±2°C, humidity 90 to 95%, 96 hours | | | |
| 6. Temperature Cycles | Contact resistance Maximum of 100mΩ Insulation resistance Minimum of 50mΩ | | (-55°C : 30 minutes → 5~35°C : 10 minutes → 85°C : 30 minutes → 5~35°C : 10 minutes) 5 cycles | | | |
| 7. Durability | Contact Resistance: maximum of 100mΩ | | 10 mating cycles | | | |
| 8. Soldering Heat Resistance | Should be no melting of resin parts that affects its performance | | Reflow : according to the Recommended Solder Profile Hand solder : Soldering iron temperature 350°C, no more than 3 seconds. | | | |

Note 1 : Includes temperature rise caused by current flow.

Note 2 : The term "storage" here refers to products stored for a long period prior to board mounting and use. The operating temperature and humidity range covers the non-energized condition of connectors after board mounting and the temporary storage conditions during transportation, etc.

Materials

| Product | Component | Materials | Finish | UL Regulation |
|------------|-----------|--------------------|--------------|---------------|
| Receptacle | Insulator | LCP | Black | UL94V-0 |
| Header | Contact | Phosphorous bronze | Gold plating | _____ |

Product Number Structure

Refer to this page when determining product specifications by model types. Please place orders with part numbers listed in this catalog. The characteristics and specifications of the product described in this catalog are reference values. Please make sure to check the latest delivery specifications at the time of product use.

●Receptacle/Header

BM 20 # () - * DS - 0.4 V (51)**

① ② ③ ④ ⑤ ⑥ ⑦ ⑧ ⑨

| | |
|---|--|
| ① Series Name : BM | ⑥ Connector Type DS : Double row receptacle DP : Double row header |
| ② Series No. : 20 | ⑦ Contact Pitch : 0.4mm |
| ③ Shape Symbols B : With reinforcing metal fitting | |
| ④ Stack height : 0.6mm, 0.8mm | ⑧ Terminal Shape V : Vertical SMT |
| ⑤ No. of Contacts : Please refer to page 3 and after. | ⑨ Packaging (51) : Embossed tape package (8,000 pieces per reel) |

■ H=0.6mm receptacle

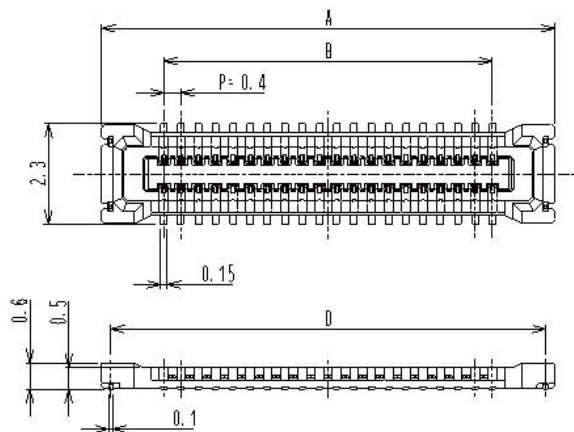
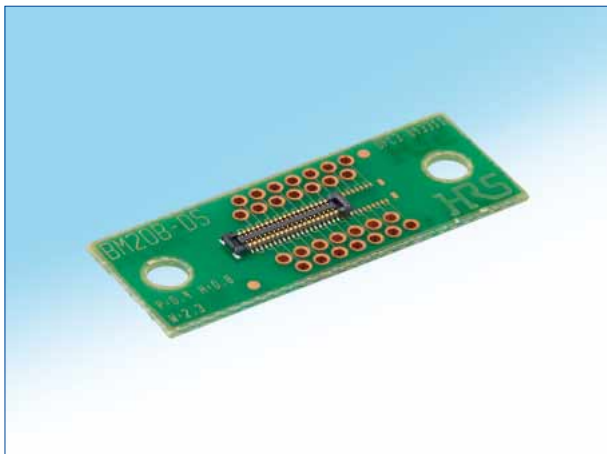

■ H=0.8mm receptacle

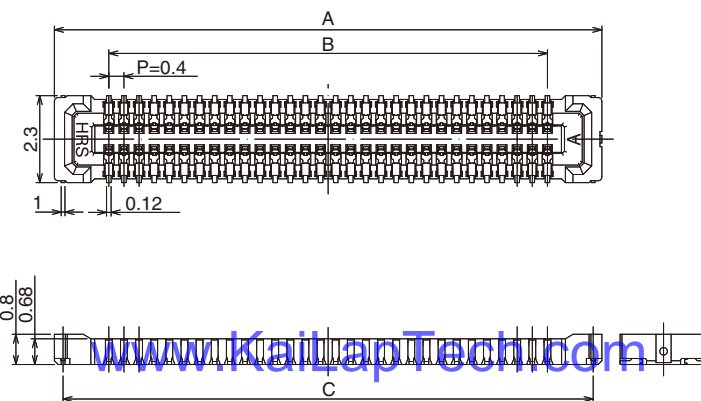
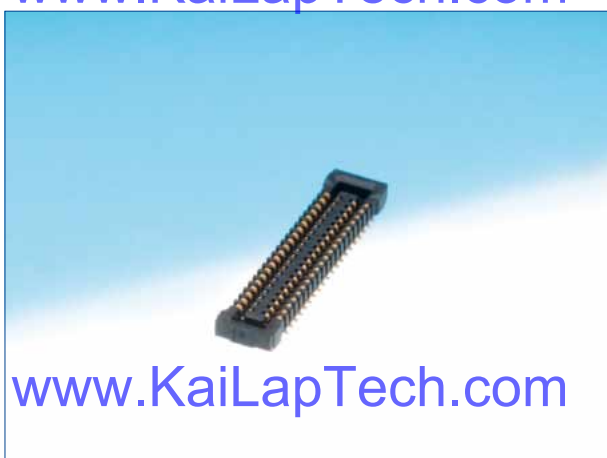

◆ Recommended PCB layout [H= 0.6mm]

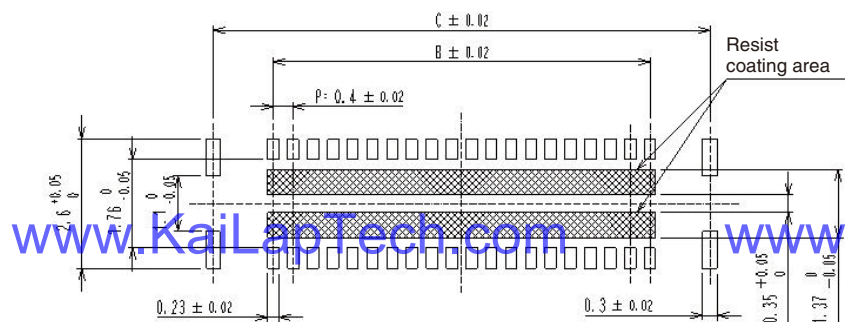

◆ Recommended PCB layout [H= 0.8mm]

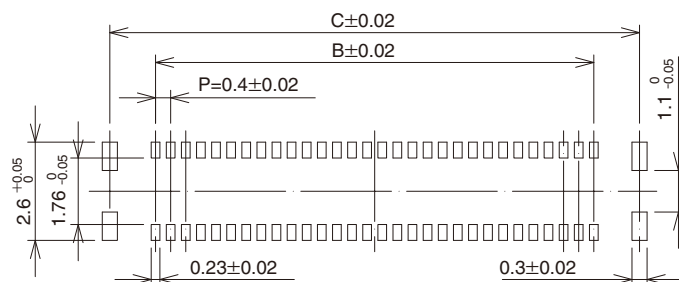

Jan. 1. 2022 Copyright 2022 HIROSE ELECTRIC CO., LTD. All Rights Reserved.

www.KaiLapTech.com

www.KaiLapTech.com

www.KaiLapTech.com

www.KaiLapTech.com

www.KaiLapTech.com

www.KaiLapTech.com

◆ Recommended metal mask size (Mask thickness 100 μm) [0.6 mm and 0.8 mm common]

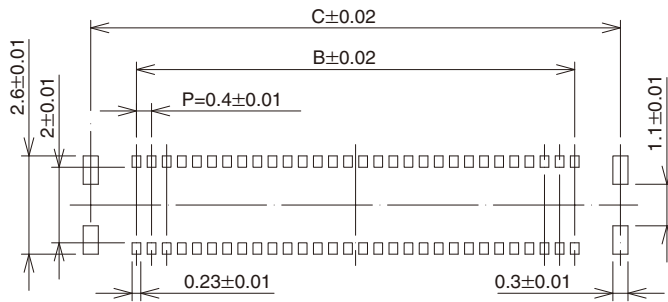

Unit : mm

| Part No. | HRS No. | No. of Contacts | A | B | C | D |
|--------------------------|----------------|-----------------|-------|------|-------|-------|
| BM20B(0.6)-10DS-0.4V(51) | 0684-9308-8 51 | 10 | 4.48 | 1.6 | 4.02 | 4.06 |
| BM20B(0.6)-20DS-0.4V(51) | 0684-9309-0 51 | 20 | 6.48 | 3.6 | 6.02 | 6.06 |
| BM20B(0.6)-24DS-0.4V(51) | 0684-9310-0 51 | 24 | 7.28 | 4.4 | 6.82 | 6.86 |
| BM20B(0.6)-30DS-0.4V(51) | 0684-9311-2 51 | 30 | 8.48 | 5.6 | 8.02 | 8.06 |
| BM20B(0.6)-34DS-0.4V(51) | 0684-9312-5 51 | 34 | 9.28 | 6.4 | 8.82 | 8.86 |
| BM20B(0.6)-40DS-0.4V(51) | 0684-9313-8 51 | 40 | 10.48 | 7.6 | 10.02 | 10.06 |
| BM20B(0.6)-50DS-0.4V(51) | 0684-9314-0 51 | 50 | 12.48 | 9.6 | 12.02 | 12.06 |
| BM20B(0.6)-60DS-0.4V(51) | 0684-9315-3 51 | 60 | 14.48 | 11.6 | 14.02 | 14.06 |

| Part No. | HRS No. | No. of Contacts | A | B | C |
|--------------------------|----------------|-----------------|-------|-----|-------|
| BM20B(0.8)-10DS-0.4V(51) | 0684-9008-4 51 | 10 | 4.48 | 1.6 | 4.02 |
| BM20B(0.8)-16DS-0.4V(51) | 0684-9041-0 51 | 16 | 5.68 | 2.8 | 5.22 |
| BM20B(0.8)-20DS-0.4V(51) | 0684-9009-7 51 | 20 | 6.48 | 3.6 | 6.02 |
| BM20B(0.8)-24DS-0.4V(51) | 0684-9010-6 51 | 24 | 7.28 | 4.4 | 6.82 |
| BM20B(0.8)-30DS-0.4V(51) | 0684-9011-9 51 | 30 | 8.48 | 5.6 | 8.02 |
| BM20B(0.8)-34DS-0.4V(51) | 0684-9020-0 51 | 34 | 9.28 | 6.4 | 8.82 |
| BM20B(0.8)-40DS-0.4V(51) | 0684-9012-1 51 | 40 | 10.48 | 7.6 | 10.02 |
| BM20B(0.8)-50DS-0.4V(51) | 0684-9013-4 51 | 50 | 12.48 | 9.6 | 12.02 |

Note 1 : This product is sold by full reel quantities of 8,000 pieces per reel. Please place orders in full reel quantities.

Note 2 : This connector is NOT polarized.

www.KaiLapTech.com

www.KaiLapTech.com

[Product Brief]

Ver.1.0

IMX214

Diagonal 5.867mm (Type 1/3.06) 13M Pixel CMOS Image Sensor with Square Pixel for Color Cameras

Description

IMX214 is a diagonal 5.867mm (Type 1/3.06) 13M pixel CMOS active pixel type stacked image sensor with a square pixel array. It adopts Exmor RS™ technology to achieve high speed image capturing by column parallel A/D converter circuits and high sensitivity and low noise image (comparing with conventional CMOS image sensor) through the backside illuminated imaging pixel structure. R, G, and B pigment primary color mosaic filter is employed. By introducing specially varying exposure technology, high dynamic range still pictures and movies are achievable. It equips an electronic shutter with variable integration time. It operates with three power supply voltages: analog 2.7 V, digital 1.0V and 1.8 V for input/output interface and achieves low power consumption. IMX214 is designed for use in cellular phones or tablet devices*.

Functions and Features

- ◆ Back illuminated and stacked CMOS image sensor Exmor RS
- ◆ Single Frame High Dynamic Range (HDR) with equivalent full pixels.
- ◆ High signal to noise ratio (SNR).
- ◆ Full resolution @30fps (Normal / HDR) 4K2K @30fps (Normal / HDR) 1080p @60fps (Normal / HDR)
- ◆ Output video format of RAW10/8, COMP8/6
- ◆ Pixel binning readout and H/V sub sampling function
- ◆ Advanced Noise Reduction (Chroma noise reduction and luminance noise reduction)
- ◆ Independent flipping and mirroring.
- ◆ CSI 2 serial data output (MIPI 2lane/4lane, Max. 1.2Gbps/lane, DPHY spec. ver. 1.1 compliant)
- ◆ 2wire serial communication
- ◆ Two PLLs for independent clock generation for pixel control and data output interface.
- ◆ Advanced Noise Reduction.
- ◆ Dynamic Defect Pixel Correction.
- ◆ Zero shutter lag.
- ◆ Power on reset function
- ◆ Dual sensor synchronization operation.
- ◆ 8K bit of OTP ROM for users.
- ◆ Built in temperature sensor

NOTE)

1. When using this product for another application, Sony does not guarantee the quality and reliability of product. Therefore, don't use this for applications other than cellular phone and Tablet PCs. Consult your Sony sales representative if you have any questions.

Device Structure

- ◆ CMOS image sensor
- ◆ Image size : Diagonal 5.867mm (Type 1/3.06)
- ◆ Total number of pixels : 4224 (H) × 3200(V) approx. 13.51M pixels
- ◆ Number of effective pixels : 4224 (H) × 3136 (V) approx. 13.25 M pixels
- ◆ Number of active pixels : 4208 (H) × 3120 (V) approx. 13.13 M pixels
- ◆ Chip size : 6.100mm (H) × 4.524mm (V)
- ◆ Unit cell size : 1.12 μm (H) × 1.12 μm (V)
- ◆ Substrate material : Silicon

Functional Description

System Outline

IMX214 is a CMOS active pixel type image sensor which adopts the Exmor RS™ technology to achieve high sensitivity, low noise and high speed image capturing. It is embedded with backside illuminated imaging pixel, low noise analog amplifier, column parallel A/D converters which enables high speed capturing, digital amplifier, image binning circuit, timing control circuit for imaging size and frame rate, CSI2 image data high speed serial interface, PLL oscillator, and serial communication interface to control these functions.

Several additional image processing functions and peripheral circuits are also included for easy system optimization by the users. A one time programmable memory is embedded in the chip for storing the user data. It has 8 K-bit for users, 10 K-bit as a whole.

Block Diagram

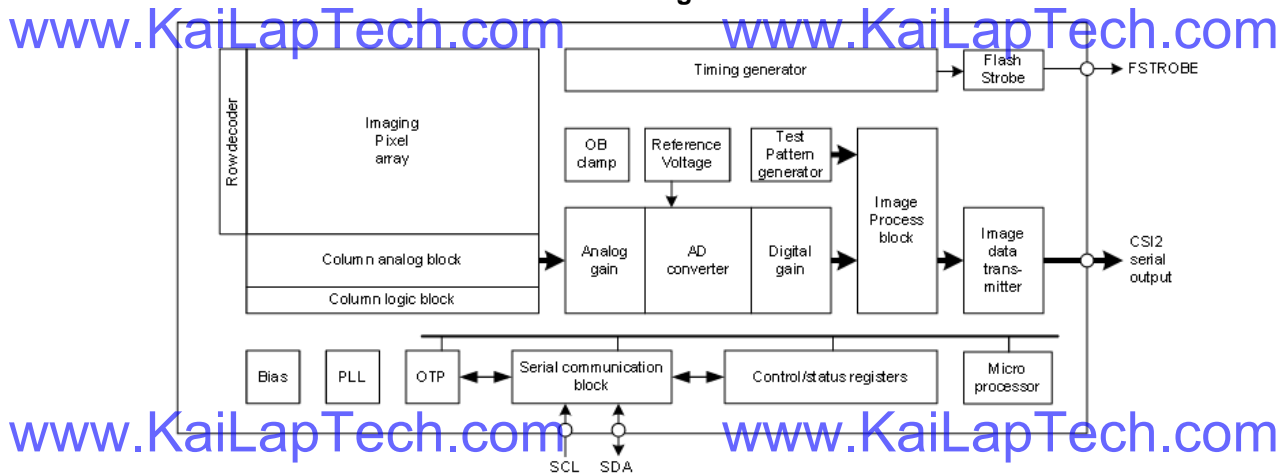

Exmor RS

* Exmor RS is a trademark of Sony Corporation. The Exmor RS is a Sony's CMOS image sensor with high-resolution, high-performance and compact size by replacing a supporting substrate in Exmor R™ which changed fundamental structure of Exmor™ pixel adopted column parallel A/D converter to back-illuminated type, with layered chips formed signal processing circuits.

Sony reserves the right to change products and specifications without prior notice.

This information does not convey any license by any implication or otherwise under any patents or other right.

Application circuits shown, if any, are typical examples illustrating the operation of the devices. Sony cannot assume responsibility for any problems arising out of the use of these circuits.

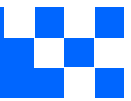

Camera Module Pinout Definition Reference Chart

| OmniVision | Sony | Samsung | On-Semi | Aptina | Himax | GalaxyCore | PixArt | SmartSens | Sensors |
|-------------------------------|------|---|---------|--------|-------|------------|--------|-----------|---------|
| Pin Signal | | Description | | | | | | | |
| DGND GND | | ground for digital circuit | | | | | | | |
| AGND | | ground for analog circuit | | | | | | | |
| PCLK DCK | | DVP PCLK output | | | | | | | |
| XCLR PWDN XSHUTDOWN STANDBY | | power down active high with internal pull-down resistor | | | | | | | |
| MCLK XVCLK XCLK INCK | | system input clock | | | | | | | |
| RESET RST | | reset active low with internal pull-up resistor | | | | | | | |
| NC NULL | | no connect | | | | | | | |
| SDA SIO_D SIOD | | SCCB data | | | | | | | |
| SCL SIO_C SIOC | | SCCB input clock | | | | | | | |
| VSYNC XVS FSYNC | | DVP VSYNC output | | | | | | | |
| HREF XHS | | DVP HREF output | | | | | | | |
| DOVDD | | power for I/O circuit | | | | | | | |
| AFVDD | | power for VCM circuit | | | | | | | |
| AVDD | | power for analog circuit | | | | | | | |
| DVDD | | power for digital circuit | | | | | | | |
| STROBE FSTROBE | | strobe output | | | | | | | |
| FSIN | | synchronize the VSYNC signal from the other sensor | | | | | | | |
| SID | | SCCB last bit ID input | | | | | | | |
| ILPWM | | mechanical shutter output indicator | | | | | | | |
| FREQ | | frame exposure / mechanical shutter | | | | | | | |
| GPIO | | general purpose inputs | | | | | | | |
| SLASEL | | I2C slave address select | | | | | | | |
| AFEN | | CEN chip enable active high on VCM driver IC | | | | | | | |
| MIPI Interface | | | | | | | | | |
| MDN0 DN0 MD0N DATA_N DMO1N | | MIPI 1st data lane negative output | | | | | | | |
| MDP0 DP0 MD0P DATA_P DMO1P | | MIPI 1st data lane positive output | | | | | | | |
| MDN1 DN1 MD1N DATA2_N DMO2N | | MIPI 2nd data lane negative output | | | | | | | |
| MDP1 DP1 MD1P DATA2_P DMO2P | | MIPI 2nd data lane positive output | | | | | | | |
| MDN2 DN2 MD2N DATA3_N DMO3N | | MIPI 3rd data lane negative output | | | | | | | |
| MDP2 DP2 MD2P DATA3_P DMO3P | | MIPI 3rd data lane positive output | | | | | | | |
| MDN3 DN3 MD3N DATA4_N DMO4N | | MIPI 4th data lane negative output | | | | | | | |
| MDP3 DP3 MD3P DATA4_P DMO4P | | MIPI 4th data lane positive output | | | | | | | |
| MCN CLKN CLK_N DCKN | | MIPI clock negative output | | | | | | | |
| MCP CLKP MCP CLK_P DCKN | | MIPI clock positive output | | | | | | | |
| DVP Parallel Interface | | | | | | | | | |
| D0 DO0 Y0 | | DVP data output port 0 | | | | | | | |
| D1 DO1 Y1 | | DVP data output port 1 | | | | | | | |
| D2 DO2 Y2 | | DVP data output port 2 | | | | | | | |
| D3 DO3 Y3 | | DVP data output port 3 | | | | | | | |
| D4 DO4 Y4 | | DVP data output port 4 | | | | | | | |
| D5 DO5 Y5 | | DVP data output port 5 | | | | | | | |
| D6 DO6 Y6 | | DVP data output port 6 | | | | | | | |
| D7 DO7 Y7 | | DVP data output port 7 | | | | | | | |
| D8 DO8 Y8 | | DVP data output port 8 | | | | | | | |
| D9 DO9 Y9 | | DVP data output port 9 | | | | | | | |
| D10 DO10 Y10 | | DVP data output port 10 | | | | | | | |
| D11 DO11 Y11 | | DVP data output port 11 | | | | | | | |



your BEST camera module partner

Cameras Applications



www.KaiLapTech.com



www.KaiLapTech.com



www.KaiLapTech.com

www.KaiLapTech.com



www.KaiLapTech.com



www.KaiLapTech.com





Camera Reliability Test

| Reliability Inspection Item | | Testing Method | Acceptance Criteria | |
|-----------------------------|--|---|-------------------------|-------------------------|
| Category | Item | | | |
| Environmental | Storage Temperature | High 60°C 96 Hours | Temperature Chamber | No Abnormal Situation |
| | | Low -20°C 96 Hours | Temperature Chamber | No Abnormal Situation |
| | Operation Temperature | High 60°C 24 Hours | Temperature Chamber | No Abnormal Situation |
| | | Low -20°C 24 Hours | Temperature Chamber | No Abnormal Situation |
| | Humidity | 60°C 80% 24 Hours | Temperature Chamber | No Abnormal Situation |
| | Thermal Shock | High 60°C 0.5 Hours Low -20°C 0.5 Hours Cycling in 24 Hours | Temperature Chamber | No Abnormal Situation |
| Physical | Drop Test (Free Falling) | Without Package 60cm | 10 Times on Wood Floor | Electrically Functional |
| | | With Package 60cm | 10 Times on Wood Floor | Electrically Functional |
| | Vibration Test | 50Hz X-Axis 2mm 30min | Vibration Table | Electrically Functional |
| | | 50Hz Y-Axis 2mm 30min | Vibration Table | Electrically Functional |
| | | 50Hz Z-Axis 2mm 30min | Vibration Table | Electrically Functional |
| Cable Tensile Strength Test | Loading Weight 4 kg 60 Seconds Cycling in 24 Hours | Tensile Testing Machine | Electrically Functional | |
| Electrical | ESD Test | Contact Discharge 2 KV | ESD Testing Machine | Electrically Functional |
| | | Air Discharge 4 KV | ESD Testing Machine | Electrically Functional |
| | Aging Test | On/Off 30 Seconds Cycling in 24 Hours | Power Switch | Electrically Functional |
| | USB Connector | On/Off 250 Times | Plug and Unplug | Electrically Functional |





| Inspection Item | | Inspection Method | Standard of Inspection | |
|------------------|----------|-------------------|-----------------------------|--|
| Category | Item | | | |
| Appearance | FPC/ PCB | Color | The Naked Eye | Major Difference is Not Allowed. |
| | | Be Torn/Chopped | The Naked Eye | Copper Crack Exposure is Not Allowed. |
| | | Marking | The Naked Eye | Clear, Recognizable (Within 30cm Distance) |
| | Holder | Scratches | The Naked Eye | The Inside Crack Exposure is Not Allowed |
| | | Gap | The Naked Eye | Meet the Height Standard |
| | | Screw | The Naked Eye | Make Sure Screws Are Presented (If Any) |
| | | Damage | The Naked Eye | The Inside Crack Exposure is Not Allowed |
| | Lens | Scratch | The Naked Eye | No Effect On Resolution Standard |
| | | Contamination | The Naked Eye | No Effect On Resolution Standard |
| | | Oil Film | The Naked Eye | No Effect On Resolution Standard |
| | | Cover Tape | The Naked Eye | No Issue On Appearance. |
| | Function | Image | No Communication | Test Board |
| Bright Pixel | | | Black Board | Not Allowed In the Image Center |
| Dark Pixel | | | White board | Not Allowed In the Image Center |
| Blurry | | | The Naked Eye | Not Allowed |
| No Image | | | The Naked Eye | Not Allowed |
| Vertical Line | | | The Naked Eye | Not Allowed |
| Horizontal Line | | | The Naked Eye | Not Allowed |
| Light Leakage | | | The Naked Eye | Not Allowed |
| Blinking Image | | | The Naked Eye | Not Allowed |
| Bruise | | | Inspection Jig | Not Allowed |
| Resolution | | | Chart | Follows Outgoing Inspection Chart Standard |
| Color | | | The Naked Eye | No Issue |
| Noise | | | The Naked Eye | Not Allowed |
| Corner Dark | | | The Naked Eye | Less Than 100px By 100px |
| Color Resolution | | | The Naked Eye | No Issue |
| Dimension | Height | The Naked Eye | Follows Approval Data Sheet | |
| | Width | The Naked Eye | Follows Approval Data Sheet | |
| | Length | The Naked Eye | Follows Approval Data Sheet | |
| | Overall | The Naked Eye | Follows Approval Data Sheet | |



KLT Package Solutions

KLT Camera Module



Complete with Lens Protection Film

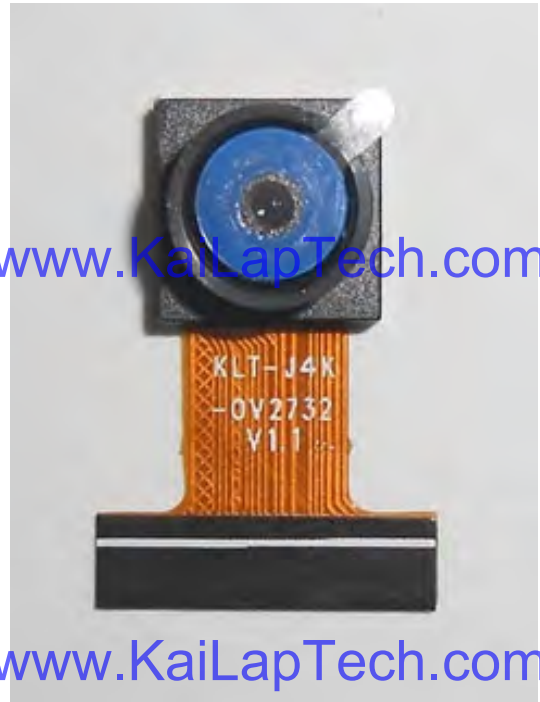

Tray with Grid and Space



Place Cameras on the Tray





Camera Modules Package Solution

Full Tray of Cameras



Cover Tray with Lid



Put Tray into Anti-Static Bag



Vacuum the Anti-Static Bag

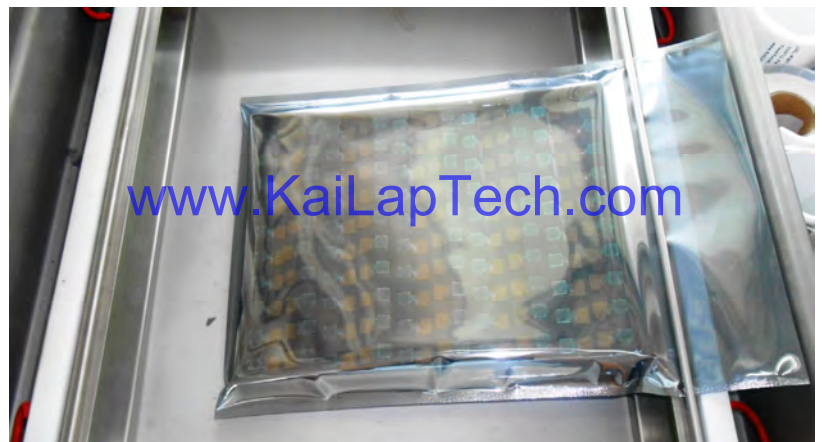



Camera Modules Package Solution

Sealed Vacuum Bag with Labels

- 1. Model and Description 2. Quantity 3. Shipping Date 4. Caution**





CMOS CAMERA MODULES



your BEST camera module partner

Large Order Package Solution

Place Foam Sheets Between Trays

Foam Sheets are Slightly Larger than Trays



www.KaiLapTech.com

www.KaiLapTech.com

Place Foam Sheets and Trays into Box

Foam Sheets are Tightly Fitting Box

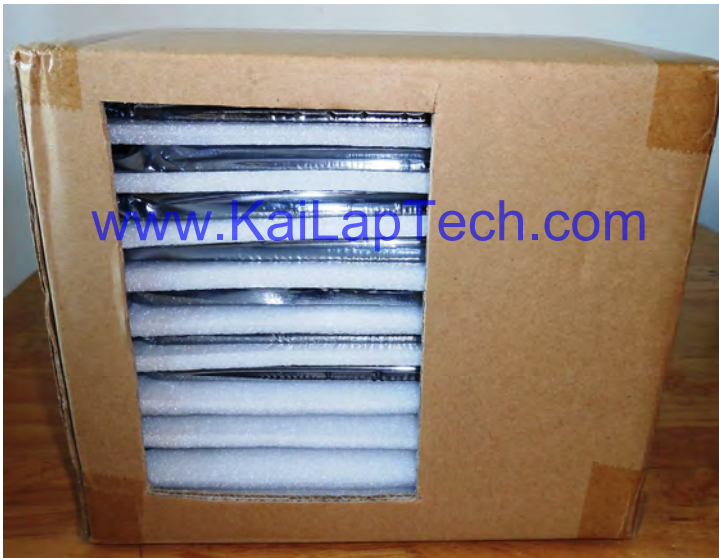



CMOS CAMERA MODULES



your BEST camera module partner

Small Order Package Solution

Place Foam Sheets and Trays into Small Box



www.KaiLapTech.com

www.KaiLapTech.com

Package in Small Box for Shipment

Foam Sheets are Nicely Fitting the Small Box



www.KaiLapTech.com

www.KaiLapTech.com

Place Small Boxes into Larger Box



www.KaiLapTech.com



www.KaiLapTech.com



your **BEST** camera module partner

Carbon Box Package Solution

Seal the Carbon Box

Final Package Labelled Box



Carbon Box Ready for Shipment

1. Delivery Address and Phone No.
2. Box No. and Ship Date
3. Fragile Caution





Sample Order Package Solution

Place Sample into Small Anti-Static Bag



Place Connectors into Small Ant-Static Bag



Sample Labels on the Small Bag

1. Camera Module or Connector Model
2. Shipping Date and Quantity
3. Caution





your BEST camera module partner

Connectors Large Order Package Solution

Connectors in a Wheel



Label Connectors in the Wheel



The Wheel is Perfectly Fitting the Box



Connectors Box Ready for Shipment



Company Kai Lap Technologies (KLT)

Kai Lap Technologies Group Limited. (KLT) was established in 2009, a next-generation technology driven manufacturer specialized in research, design, and produce of audio and video products. KLT is occupying 20,000 square feet automated plants with 100 employees of annual throughput 30,000,000 units cameras.

KLT provides OEM, ODM design, contract manufacturing, and builds the camera products. You may provide the requirements to us, even with a hand draft, our sales and engineering work together to meet your needs. We consider ourselves your last-term partner in developing practical and innovative solutions.

Our team covers everything from initial concept development to mass produced product. KLT specializes in customized camera design, raw material, electronic engineering, firmware/software development, product testing, and packing design. Our experienced strategic supply systems offer a robust and dependable manufacturing capacity for orders of various sizes.

www.KaiLapTech.com

www.KaiLapTech.com



Limited Warranty

KLT provides the following limited warranty if you purchased the Product(s) directly from KLT company or from KLT's website, www.KaiLapTech.com. Product(s) purchased from other sellers or sources are not covered by this Limited Warranty. KLT guarantees that the Product(s) will be free from defects in materials and workmanship under normal use for a period of one (1) year from the date you receive the product ("Warranty Period").

For all Product(s) that contain or develop material defects in materials or workmanship during the Warranty Period, KLT will, at its sole option, either: (i) repair the Product(s); (ii) replace the Product(s) with a new or refurbished Product(s) (replacement Product(s) being of identical model or functional equivalent); or (iii) provide you a refund of the price you paid for the Product(s).

This Limited Warranty of KLT is solely limited to repair and/or replacement on the terms set forth above. KLT is not reliable or responsible for any subsequent events.





CMOS CAMERA MODULES



your BEST camera module partner

KLT Strength

Powerful Factory



Professional Service



Promised Delivery



www.KaiLapTech.com sales@KaiLapTech.com Tel: (852) 6908 1256 Fax: (852) 3017 6778

All rights reserved @ Kai Lap Technologies Group Ltd. Specifications subject to change without notice.